



AL DAOUR FOR METAL INDUSTRIES

Company Profile



BUREAU VERITAS
Certification



ISO 9001 : 2008

Table Of Contents

1.0 Introduction

- 1.1 Company Profile
- 1.2 Board of Directors
- 1.3 Machinery & capability

2.0 Certificates and Legal Documents

- 2.1 Legal Registration & Governmental Documents
- 2.2 ISO Certificate
- 2.3 UL Certificate
- 2.4 Approvals & Thanking Certificates

3.0 Quality Overview

- 3.1 Vision Statement
- 3.2 Mission Statement
- 3.3 Quality Policy

4.0 Selective Projects.

5.0 Our Products

- 5.1 General Overview about ADF Metal Doors & Frames
- 5.2.General Doors
- 5.3.Fire Resistant Doors
- 5.4.Fully Louver Doors & Fixed Louvers
- 5.5 Knock Down Frames
- 5.6 Access Panels
- 5.7 X-Ray Doors (Lead Line Doors)
- 5.8 Fixed Windows & Front Shops

6.0 Contacts

- 7.1 Contact Details & Site Map.

Table Of Contents



AL DAOUR FOR METAL INDUSTRIES



Introduction

We at *Al-Daour Metal Industries* emphasize quality in our complete line of Hollow Metal Doors, Frames, and Architectural Hardware. Our commercial grade products provide long lasting durability and security to your business, educational buildings, industrial foundations and residential applications. We will custom build Doors and/or Frames for any size or design to meet your specifications. We also service and install any of our products to fit your needs.

ADF Hollow Metal Door services all of Governmental and Special projects, and ships to any place in the Middle East & the GCC.

We can provide you with an unlimited variety of doors to meet any design requirement. Doors can be flush (no windows), or we can supply light openings (windows) of any size in the door, or any kind of grills, shutters and louvers in any required sizes.

ADF can provide a variety of internal cores to meet your building requirements and fire protection needs like Honeycomb, Steel-Stiffened, Polystyrene, and Polyurethane.

We can also provide stile and rail doors for full glass or full louver applications. We have doors available from 12 gauge to 20 gauge.

Through superior craftsmanship, innovation, and long years of engineering excellence, **ADF** remain one of the leaders and experts in the field of hollow metal industries here in the GCC, extending our leadership by continuously providing the high quality products, the best consulting, the optimum specifying and the after sale services in the hollow metal industry to help our customer in performing their projects in a manner meets or exceeds the requirements of the end users.



Company Profile

Al-Daour factory for metal industries  was founded in 2001 as a part of the BETA group which were founded in 1977; to join a group of affiliated companies dedicated to offer the high quality products and services in the hollow metal industries, with root stretching back to 1977 we will take a look to the story of success for BETA GROUP.

Beta group of Companies is one of the fastest growing Commercial Enterprises with large Importing, Exporting and Manufacturing agencies in the United Arab Emirates.

The Beta Group started its operations with Electrical Contracting. Today, it has expanded to 5 Companies with branches in Abu Dhabi, Riyadh and Jeddah and has over 800 employees on its payroll.

The Beta Group realizes that it owes much of its success to its staff of professional employees, whom it considers to be the Group's greatest assets. The entire team of Beta's consists of qualified Engineers and employees drawn from the Electrical, Mechanical, Computer or Networking Fields. Each possesses excellent Product knowledge and is capable of satisfying all requirements of our Clients and specifying the best solutions to them. The Technical Staff are equally qualified and regularly undergo training courses conducted by Beta's Principals.

Beta Group consists of:

- *Beta Industrial LLC*
- *Beta Information Technology LLC*
- *Dar Beta Information Technology – Riyadh*
- *Precision Industries*
- *MM Al Daour Factory - Riyadh*

Introduction

M.M.AL DAOUR FACTORY**Address**

P.O. BOX: 355671, RIYADH 11383 – KSA Web Site: www.adf.com.sa
 TEL: +966 1 2654551; +966 1 2654552, FAX: + 966 1 2654550
 E-Mail: ahmed.daour@adf.com.sa

PRECISION INDUSTRIES**Address**

P.O. BOX: 37448, DUBAI – UAE Web Site: www.pi-dubai.com
 TEL: +971 4 338 4033 FAX: + 971 4 338 3997 E-Mail: info@pi-dubai.com

COUNTRY OF REGISTRATION: DUBAI – UAE, RIYADH – K.S.A

FOUNDED: 2001/2005

ACTIVITIES:

M.M.Al Daour Factory - Riyadh is a fully fledged facility to carry out a wide range of production activities for manufacturing hollow metal doors and frames, A/C Accessories and Metal Cabinets in Riyadh. It is a new concept at the local market specialized to service the industry with high precision high custom made metal components at affordable prices and affordable delivery irrespective of quantity. Through the variety of the state of the art flexible manufacturing CNC laser, CNC punching & CNC bending system it is possible to process wide range of Complicated & sharp tolerance components in different size & quantities. This gave us the chance to be one of the creative leaders in the region.

Precision Industries – Dubai provides tailored power solution –PI Diesel Generator sets and Canopies with various types covering the power range from 9KVA to 2000 KVA - to the most challenging power requirement of even the most exaction customers. Assuring our customers that every generator set complies with most rigid levels of quality, efficiency and safety, whether it is an automatic emergency standby system or a generator set for prime power full load applications. They have production facility located in Dubai, UAE. It is supervised by highly specialized team, and equipped with CNC machinery, powder coating system and assembly lines equipped to deliver high quality components needed for all our power generation and distribution systems.

PI Diesel Generators are powered by the high quality genuine Perkins Engines coupled with the well known reliable genuine alternators such as LEROY SOMER® and STAMFORD®



BETA INFORMATION TECHNOLOGY L.L.C.

Address

P.O. BOX: 19085, DUBAI – UAE Web Site: www.betait.net
TEL: +971 4 286 8789 FAX: + 971 4 286 8443 E-Mail: beta@betait.net

DAR BETA INFORMATION TECHNOLOGY

Address

P.O. BOX: 19389, RIYADH 11435 – KSA Web Site: www.betait.net
TEL: +966 1 200 6066 FAX: + 966 1 200 6400 E-Mail: beta@betait.net

BRANCH:

P.O. BOX: 127017, JEDDAH 21352 – KSA Web Site: www.betait.net
TEL: +966 2 261 6880 FAX: +966 2 261 6889 E-Mail: beta@betait.net

BRANCH:

P.O. BOX: 6140, DAMMAM 32232 – KSA Web Site: www.betait.net
TEL: +966 3 857 1019 FAX: +966 3 857 1016 E-Mail: beta@betait.net

COUNTRY OF REGISTRATION: DUBAI – UAE, RIYADH – K.S.A

FOUNDED: 1990

ACTIVITIES:

Beta IT is one of the Middle East market leaders in the field of data communication, data security and networking. Our services offering includes: consultancy, design, systems engineering project management, service level agreements, training & system documentation

Introduction

*Beta Industrial LLC***Address:**

P.O. BOX: 50708, DUBAI – UAE; Web Site: www.betag.com
 TEL: +971 4 706 9777 FAX: + 971 4 706 9787 E-Mail: betai@betag.com

BRANCH:

P.O. BOX: 25204, ABU DHABI – UAE; Web Site: www.betag.com
 TEL: +971 2 645 0107 FAX: + 971 2 645 0167 E-Mail: betai@betag.com

COUNTRY OF REGISTRATION: DUBAI – UAE

FOUNDED: 1989

ACTIVITIES:

BETA INDUSTRIAL LLC: Broadly classified into two divisions dealing in the Trading of Electro-Mechanical products [formerly Beta Trading Co. LLC] and Manufacturing of Aluminium Air Terminal Devices (Grills, Diffusers and Duct Accessories for Central Air-conditioning) based on qualified and approved International Standards. The Company is the first in its field to be certified to ISO 9001 standards in the Gulf and Middle East. The factory also has its own modern specialized Powder Coating Plant. There is also an additional plant in Al Quoz.

Over the past years it has evolve, improve and developed its activities and expanded its range of assets by start also producing Volume Control dampers, Fire dampers, Access Doors, Sound Attenuators and VAV. It is also tied up with M/S Air zone of Spain to provide Grills and Diffusers for Zoning Systems.

Beta products lead the market in UAE and are also exported to over 40 Countries

Beta group deals with many reputable brands in all over the world, in order to meet the requirements of its dear customer, by providing them the best essence of the world wide experts in the field like:

Beghelli – Italy / Prazisa - Germany / Wilson – Singapore / Ducab – UAE / Clipsal – Australia / Beta – Cable support Systems – GI Cable Trays, Trunking and Accessories made by Beta - UAE. Vortice – Italy / Howden Donkin – South Africa / Supervent Fans – Beta – UAE / Grills and Diffusers, Volume and Fire Dampers, Sound Attenuators and VAV, Access Doors / AFS Duct Accessories-Turkey / Air zone Zoning Systems – Spain / Netrack – Networking cabinets made by Beta – UAE

BOARD OF DIRECTORS

MR. MOHAMMED DAOUR: Chairman

MR. RASHID DAOUR: Director

MR. BASSAM NAZZAL: Director

MR. MOTASIM DAOUR: Director

MR. OSAMA DAOUR: Director

MR. GHASSAN SHAKER: Director

MR. MAMOUN DAOUR : Director

Introduction



Machinery

SR	NAME OF MACHINES	QTY
1	BYSTAR LASER,	1
2	FINN POWER CNC PUNCHING.	2
3	BYKAL CNC BENDING	3
4	BYKAL NC BENDING	1
5	FINN POWER CNC HDY PUNCHING	1
6	ELECTRICAL FINN POWER BENDING	2
7	IMAL BENDING	1
8	DURMA BENDING	1
9	ROLL BEDING MACHINE	1
10	FOAM INJECTION	1
11	PORTABLE SPOT WELDING.	1
12	POWDER COATING LINE	1
13	POWDER COATING SPRY MANUAL	1
14	MILLER MIG WELDING MACHIINE	14
15	MAXIMA SHARING MACHINE	1
16	SPOT WELDING MACHINES	6
17	DECA WELDING MACHINES	2
18	BABY GRANDER	12
19	DRILL MACHINES	7
20	RECHARGEABLE DRILLS	2
21	DRILL PRESS	1
22	TUBE CUTER	1
23	FORKLIFT CATER PILLER	1
24	FORKLIFT DOSAN	1
25	AIR COMPRESSORS ATLAS COPCO	2
26	AIR COMPRESSORS LOCAL	1
27	AIR DRYERS ATLAS COPCO	2



**Certificates and
Legal
Documents**

المملكة العربية السعودية
وزارة التجارة والاستثمار

شهادة تسجيل الشركة

الرقم: ١٠١١٧٨٠٣
التاريخ: ١٤٣٧هـ/٤٤٤٠

الاسم التجاري للمؤسسة: معتم محمد الداوير للمعاملات المصرفية
مركزها الرئيسي: الرياض - المنطقة الصناعية الثالثة بالحياتين
ص.ب: ٧٧١ البرمز البريدي: ١١٢٨٣ الهاتف: ٢٦٤٥٥٥١ فاكس: ٢٦٥٤٥٠
اسم التاجر (وإنشأه): محمد محمد رشيد الداوير الجنسية: أردني تاريخ الميلاد: ١٩٦٤
رقم السجل المدني: الإقامة: ٠٠٦١٢-٥٢٢٢٠١ تاريخه: ١١٢٥٠١٢٠٥ مصدره: الرياض
رقم الحافظة الجوز: ٣٠٨١٠٥ تاريخه: ١٩٩٦٠٩٢٠ مصدره:
النشاط: أنتاج اموال واستثمار فنيما في تكييف وتعليق وتكامل معدنيات البناء غير مخصصه انجليزية
وكيفيات معدنية مثل اذنانها مستخدمون معدنية في تكييف وتعليق معدنية في تكييف وتعليق معدنية في تكييف
معدنية مثل اذنانها مستخدمون معدنية في تكييف وتعليق معدنية في تكييف وتعليق معدنية في تكييف
ومعدنية مثل اذنانها مستخدمون معدنية في تكييف وتعليق معدنية في تكييف وتعليق معدنية في تكييف
معدنية مثل اذنانها مستخدمون معدنية في تكييف وتعليق معدنية في تكييف وتعليق معدنية في تكييف

رأس المال: ٦٥٠٠٠٠٠٠٠٠٠
اسم المدير أو الوكيل المفوض: معتم محمد رشيد الداوير
الجنسية: أردني
رقم السجل المدني: الإقامة: ٠٠٦١٢-٥٢٢٢٠١ تاريخه: ١٩٦٤ تاريخ الميلاد: ١٩٦٤
سلطات المدير: اذنانها مستخدمون معدنية في تكييف وتعليق معدنية في تكييف وتعليق معدنية في تكييف
يشهد مكتب السجل التجاري بمدينة الرياض من تاريخ التسجيل هذه المؤسسة بتسجيل مدينة
١٤٣٧هـ/٤٤٤٠
وتتضمن صلاحية الشهادة في ٣٠٤٤١٧



التوقيع: محمد علي الداوير
الختم

Kingdom of Saudi Arabia
Ministry of Labour
Labour Office in Riyadh
Recruitment Department.

المملكة العربية السعودية
وزارة العمل
مكتب العمل بمنطقة الرياض
إدارة التوظيف

شهادة

يقيد مكتب العمل بمنطقة الرياض بأن: مصنع معتصم الداور للصناعات المعدنية

رقم الحاسب الآلي: ١- ٩٩٤٤٥

✓ ملتزمة بما يوجب تحقيق السعودة المحددة.
✗ لا يسري عليها تطبيق النسبة المطلوبة لزيادة السعودة.

وقد منحت هذه الشهادة وفق تعميم صاحب السمو الملكي وزير الداخلية
رقم ٤٧٥/ع وتاريخ ١٤٢١/٦/١٨ هـ وذلك بناءً على طلب المنشأة.
وتعتبر سارية المفعول لمدة: عام من تاريخه

المدير العام
لمكتب العمل بمنطقة الرياض المكلف
محمد بن حسن القصير
١٤١٦

الختم

١٤٢٣/٠١/١٣ ٥/٣٠٩

General Organization for Social Insurance

المؤسسة العامة للتأمينات الاجتماعية

Riyadh R Office

مكتب منطقة الرياض

١٠٢٤٥٣٥٣ الرقم التاريخ ١٤٣٢/٠١/٠٢ الموافق ٢٠١٠/١٢/٠٨

شهادة

اسم المنشأة : مصنع معصم الداور لمستلزمات التكييف
 اسم صاحب العمل : معصم محمد رشيد الداور
 ص.ب : ٣٥٦٧١ الرياض ١١٣٨٣ السعودية

رقم الإشتراك : ١٣٣٤٣٣١
 رقم السجل التجاري : ١٠١٠١٦٧٨٠٢ مصدره : الرياض

رقم	كثافة	عدد المشتركين السعوديين
١٥	خمسة عشر مشتركاً	
١١١	مائة واحد عشر مشتركاً	عدد المشتركين غير السعوديين
١٢٦	مائة وستة وعشرون مشتركاً	المجموع

تشهد المؤسسة العامة للتأمينات الاجتماعية بأن المنشأة المذكورة أعلاه قد أوفت بالتزاماتها تجاه المؤسسة وفق البيانات المقدمة منها حتى تاريخ إصدار هذه الشهادة ، والتي تم منحها لتقدمها لأية جهة تطلبها ، وهي صالحة لجميع الأغراض التي نحن عليها نظم للتأمينات الاجتماعية في المادة (٦/١٩) منه .

هذه الشهادة سارية المفعول حتى ١٤٣٢/٠٧/٠٢ هـ
 (الثاني من شهر رجب لعام ألف واربعمائة وثلثون وثلثون هجرية)

مدير عام مكتب منطقة الرياض
 عبدالرحمن بن حمود الموسى

المملكة العربية السعودية
 المؤسسة العامة للتأمينات الاجتماعية
 General Organization for Social Insurance
 مكتب منطقة الرياض

- لا يعتد إلا بأصل هذه الشهادة لجميع الأغراض.
- تعتبر هذه الشهادة لاغية في حالة وجود كسب أو شطب عليها.

مكتب منطقة الرياض صلتوق بريد ٢٦٥٢ الرياض ١١٤٦١ - هاتف : ٤٧٦٥٧٠٠ - فاكس : ٤٧٦٥٧٠٠ - بريد إلكتروني : ٣١٠٨
 P.O.Box2852 Riyadh 114611 - Tel:4765700-Fax:Ext:3100 Web:Site:www.gosi.gov.sa E-mail:ryd@gosi.gov.sa

الرقم السوفم
 ١٠٢ / ١٤٤٧
 التاريخ
 ١٤٣٣-١٠-٢٥
 المرفقات
 الموضوع : خطاب تسهيل

المملكة العربية السعودية
 وزارة المالية
 مصلحة الزكاة والنقل
 فرع الرياض

الرقم المميز ٣٠٠٠٤٨٤٦٦١

خطاب تسهيل

(غير صالح لسرف المستحقات العادية والنهائية)

تفيد مصلحة الزكاة والنقل بعدم الممتعة من تمكين المكلف/ مصنع معتمد الداعور
 للصناعات المعدنية.
 سجل رقم ١٠١٠١٦٢٨٠٢ من إنهاء جميع معاملاته ما عدا صرف المستحقات المالية سواء كانت
 عادية أو نهائية.
 يسري صلاحية هذا الخطاب حتى تاريخ ١٤٣٣-٢٠-٦ هـ الموافق ٢٠١١-١٢-٣١ م.
 (الساس من سقر سنة الف واربعائه وثلاثة وثلاثون للهجرة).

مدير عام فرع المصلحة بالرياض
 صالح بن ابراهيم الصريخ

الختم الرسمي
 مصلحة الزكاة والنقل
 فرع الرياض



Certificate of Compliance

Certificate Number: 20090122-R25863
 Report Reference: R25863, 2008 August 14
 Issue Date: 2009 January 22

Page 1 of 1



**Underwriters
 Laboratories Inc.**

Issued to: Motasim Al-Daour Factory

3rd Industrial Area,
 Riyadh 355671 Saudi Arabia

*This is to certify that
 representative samples of*

Fire Door And Window Frames

Door Frames for use as a component in fire door assemblies that meet the requirements of UL 10B (neutral pressure):
 Three-sided single swing, transom frames with transom bars and frames for standard pairs.

Have been investigated by Underwriters Laboratories Inc.® in accordance with the Standard(s) indicated on this Certificate.

Standard(s) for Safety: "Standard For Safety For Fire Tests of Door Assemblies," UL 10B Tenth Edition Dated FEBRUARY 7, 2008 and UL Subject 63.

Additional Information: N/A

Only those products bearing the UL Listing Mark should be considered as being covered by UL's Listing and Follow-Up Service.

The UL Listing Mark generally includes the following elements: the symbol UL in a circle, with the word "LISTED"; a control number (may be alphanumeric) assigned by UL; and the product category name (product identifier) as indicated in the appropriate UL Directory.

Look for the UL Listing Mark on the product

Issued by *Laxmaya Govardhanam*

Laxmaya Govardhanam, Customer Service Professional

UL India Private Limited

Any information and documentation involving UL Mark services are provided on behalf of Underwriters Laboratories Inc. (U.S.) or any authorized licensee of UL. For questions in India you may call +91 80 4130396.

Reviewed by *Matthew Schumann*

Matthew Schumann, Senior Project Engineer

Underwriters Laboratories Inc.

Certificate of Compliance

Certificate Number: 20090122-R25864
 Report Reference: R25864, 2008 September 18
 Issue Date: 2009 January 22

Page 1 of 2



Underwriters
Laboratories Inc.®

Issued to: Motasim Al-Daour Factory

3rd Industrial Area,
Riyadh 355671 Saudi Arabia

*This is to certify that
representative samples of*

Swinging-Type Fire Doors
Refer to Addendum Page for Product Details

*Have been investigated by Underwriters Laboratories Inc.® in
accordance with the Standard(s) indicated on this Certificate.*

Standard(s) for Safety: "Standard For Safety For Fire Tests of Door Assemblies," UL 10B Tenth Edition
Dated FEBRUARY 7, 2008

Additional Information: N/A

Only those products bearing the UL Listing Mark should be considered as being covered by UL's Listing and Follow-Up Service.

The UL Listing Mark generally includes the following elements: the symbol UL in a circle:  with the word "LISTED"; a control number (may be alphanumeric) assigned by UL; and the product category name (product identifier) as indicated in the appropriate UL Directory.

Look for the UL Listing Mark on the product

Issued by: *Lavanya Govardhanam*

Lavanya Govardhanam, Customer Service Professional

UL India Private Limited

Any information and documentation regarding UL Listing services are provided on behalf of Underwriters Laboratories Inc. (UL) or any authorized Division of UL.
For questions in India you may call 191-08-4138888.

Reviewed by: *Matthew Schumann*

Matthew Schumann, Senior Project Engineer

Underwriters Laboratories Inc.

Certificates and Legal Documents

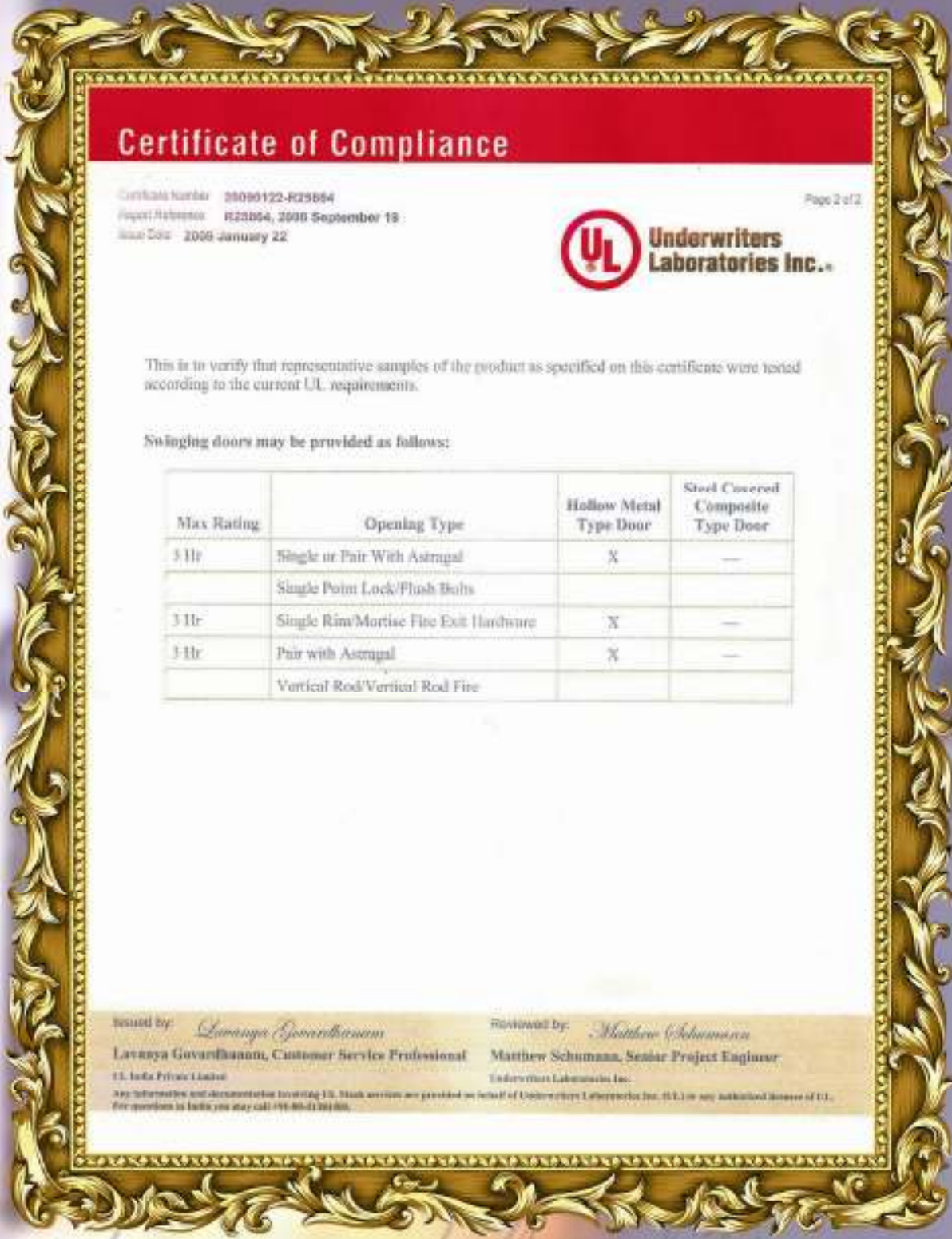

Certificate of Compliance

Certificate Number: 28090122-R28884
 Report Reference: R28884, 2908 September 18
 Issue Date: 2008 January 22

Page 2 of 2



This is to verify that representative samples of the product as specified on this certificate were tested according to the current UL requirements.

Swinging doors may be provided as follows:

Max Rating	Opening Type	Hollow Metal Type Door	Steel Covered Composite Type Door
3 Hr	Single or Pair With Astragal	X	—
	Single Point Lock/Flush Bolts		
3 Hr	Single Rim/Mortise Fire Exit Hardware	X	—
3 Hr	Pair with Astragal	X	—
	Vertical Rod/Vertical Rod Fire		

Issued by: *Lavanya Govardhanam*
 Lavanya Govardhanam, Customer Service Professional
 UL India Private Limited

Reviewed by: *Matthew Schumann*
 Matthew Schumann, Senior Project Engineer
 Underwriters Laboratories Inc.

Any information and documentation involving UL Mark services are provided on behalf of Underwriters Laboratories Inc. (UL) or any authorized licensee of UL. For questions in India, you may call +91-80-43331800.

Certificates and Legal Documents



Quality Overview



Vision Statement

Globally competitive factory with concentrate to produce world class high quality metal doors, frames and other light sheet metal works, meeting customer satisfaction, believing in high quality systems with view to enhance share holders value.



Mission Statement

ADF's continuing challenge and mission is to proactively design, produce and supply the premium Hollow Metal Doors, Hardware with all its functions, Metal Cabinets and Sheet Metal works for the GCC with the highest level of quality and affordability meeting the needs of the steel door and frame industry to all levels of customers; while creating a model company that honors commitments to customers, employees, community, and suppliers.



Quality Policy

Our quality policy simply can be summarized as satisfy customer needs and expectations by delivering products that are verified to meet the agreed requirements, on time. Also monitor and continuously improve business, products and services, organization and employees performance.

We at ADF are committed to total customer satisfaction at all times with maximum effectiveness. We are developing our team through involvement, training and effective communication. We are charged with responsibility to meet customer requirement and continually improve the quality in keeping with our objective.

ADF Quality Policy is to be the Best Customer Satisfier by providing Products of the highest quality. ADF commits and empowers its employees to implement this policy through making our customers' total experience with ADF the best in the industry, clearly understand customer needs and provide products that meet those needs, Integrate quality management principles into critical business processes and decision-making practices, continuously improve the effectiveness of the Quality Management System, our processes and products to enhance their value for our customers, shareholders, and employees, also establish quality requirements and ensure suppliers, partners and contractors comply with them and maintain our Quality Management System to conform to the requirements of ISO9001.





Selective Projects



LIST OF PROJECTS

قائمة المشاريع

المنطقة	اسم المشروع	الرقم
رفحاء	كلية التقنية	1
العيص	كلية التقنية	2
الحناكية	المعهد التقني الفني	3
خبير	المعهد التقني الفني	4
رائيا	كلية التقنية	5
الليث	المعهد التقني الفني	6
الوجه	كلية التقنية	7
القصيم	المعهد التقني الفني - ثادق	8
القصيم	المعهد التقني الفني - البكرية	9
حفر الباطن	المعهد التقني الفني - الحريج	10
جدة	كلية التقنية	11
ضبا	كلية التقنية	12
جيزان	معهد الدابر التقني الفني	13
الرياض	معهد الاطاولية التقني الفني	14
محابل عسير	كلية التقنية	15
جدة	كلية اعداد المدرسين	16
الرياض	جامعة الأميرة نورة بنت عبد الرحمن	17
حفر الباطن	مراكز تدريب وسكن الأمن العام	18
الرياض	مراكز تدريب وسكن الأمن العام	19
المدينة المنورة	مراكز تدريب وسكن الأمن العام	20
خميس مشيط	مركز تدريب وسكن القوات الجوية	21
تبوك	مركز تدريب وسكن القوات الجوية	22
الرياض	الوطني الحرس	23
تبوك	الوطني الحرس	24
البطحاء	مركز فحص الشاحنات علي منفذ البطحاء	25
الدرة	مركز فحص الشاحنات علي منفذ الدرّة	26
الرياض	مركز موبايلى للاتصالات	27
الرياض	مبنى التحكم بقرية الإتصالات	28
جيزان	ميناء جيزان	29
جدة	مبنى الجودة النوعية بميناء جدة الاسلامى	30
جدة	وحدات تتبع لوزارة الكهرباء بميناء جدة الاسلامى	31
الرياض	مركز البريد السعودى	32
الرياض	مستوصف خريص الطبى	33
الرياض	مستودع مستشفى ثابتى الطبى	34
الخفجى	بنك البلاد	35
حراء	بنك البلاد	36
الرياض	بنك ساب	37
الرياض	مركز بلدا التجارى	38
المملكة	مصانع ومطاعم هرفى	39
الرين	مركز الرين للشؤون البلدية	40
جدة	داتا سنتر	41
الرياض	المجمعات السكنية بالتحلية	42
الرياض	مركز الماس بلازا	43
جدة	قصر حطين	44
جدة	قصر هيتين	45
الخبر	الشبلان تاور (برج تجارى)	46
الرياض	بروتون للتقنية (مشروع خاص)	47
الدمام	مركز تجارى بوابة المينا	48

LIST OF PROJECTS

قائمة المشاريع

المزاحية	مجمع تحفيظ القرآن الكريم	49
مكة المكرمة	مدرسة بن المنذر (بنين)	50
مكة المكرمة	مدرسة نوفل بن حارثة (بنين)	51
الطائف	مدرسة الامام النووي (بنين)	52
مكة المكرمة	مدرسة عامر بن ربيعة (بنين)	53
عفيف	مدرسة عبدالله بن عباس (بنين)	54
تبوك	مدرسة صهيب بن سنان وصالة رياضية (بنين)	55
تبوك	مدرسة ابتدائية الصاحبية وصالة رياضية (بنين)	56
تبوك	مدرسة ابتدائية الإمام ابو حنيفة (بنين)	57
تبوك	مجمع الزيتة التعليمي (بنين)	58
تبوك	مدرسة ابي بن كعب (بنين)	59
تبوك	مجمع القادسية التعليمي ابتدائي (بنين)	60
تبوك	مجمع القادسية التعليمي ثانوي (بنين)	61
تبوك	مجمع المنشية التعليمي وصالة رياضية (بنين)	62
القصيم	مجمع مدارس (بنين)	63
الرياض	مجمع مدارس (بنين)	64
الرياض	مجمع عبد الحمين الفيصل التعليمي (بنين)	65
الرياض	مجمع ابي داود التعليمي (بنين)	66
الرياض	مجمع المقرزي التعليمي (بنين)	67
الرياض	مجمع الملك عبد العزيز التعليمي (بنين)	68
الرياض	بتدانية محدثة التعاون (بنين)	69
مكة المكرمة	مجمع شبراخليل (بنات)	70
مكة المكرمة	مجمع الشرائع (بنات)	71
مكة المكرمة	مجمع الجمجوم (بنات)	72
القصيم	مدرسة عنيزة (بنات)	73
المدينة المنورة	مجمع حي الوزارة الدفاع (بنات)	74
أبهر - جدة	مدرسة أبهر الشمالية (بنات)	75
جدة	مجمع حي الشاطيء الذهبي (بنات)	76
الدمام	مجمع حي السلام (بنات)	77
المدينة المنورة	مجمع العزيزية (بنات)	78
المدينة المنورة	مجمع حي الحصين (بنات)	79
جدة	مجمع الروضة (بنات)	80
جدة	مشاريع سكن حراس لوزارة التربية والتعليم (بنات)	81
الرياض	مجمع ابو بكر (بنات)	82
الدمام و الإحساء	مجمع ابو سحبل و المزروع (بنات)	83
عدة مناطق في المملكة	مجمعات مدارسية نموذج 680/17 (بنات)	84
بريدة	مجمع حي سلطنة (بنات)	85
سعيدة	مدرسة قرية العليا (بنات)	86
الثقبة - الخبر	مدرسة جبل النور (بنات)	87
الدمام	مجمع الفصلية (بنات)	88
الإحساء	مدرسة منيفة (بنات)	89
نجران	جامعة نجران	90
نجران	مجمع محاكم تبوك	91
تبوك	مستشفى الصحة النفسية وزارة الصحة	92
بيشاه	مستشفى الصحة النفسية وزارة الصحة	93
انحاء المملكة	مركز المشروعات التطويرية وزارة الداخلية	94

The image shows a collection of metal plates of various shapes (diamond, triangle, square) with holes at their corners, set against a background of a perforated metal mesh. The largest plate is a diamond shape and features the ADF logo and the text 'Our Products' in red. The logo consists of the letters 'ADF' in a stylized, metallic font with a starburst symbol inside the letter 'D'.

ADF[®]
Our Products

General Overview about ADF Metal Doors & Frames

DESCRIPTION:

This specification applies to standard hollow metal doors, frames and their components as shown on plans, drawings and data sheets that are manufactured by Al-Daour for Metal Industries ADF

PRODUCTS COVERED:

Swinging type hollow metal doors intended for commercial, industrial and residential use.

DOOR SIZES:

Door panel thicknesses is 48mm. (1-3/4) thick single or double swing doors having 0.8mm. -1.2mm. (Guage18) thick galvanized steel faces with a maximum door width of 1100mm. (43-1/3) and a maximum height of 2600mm. (102-1/3) for each door leaf. Exceeding the maximum door sizes can be constructed with a different approach in door construction methodologies with additional supports & reinforcements.

DOOR CONSTRUCTION:

Details of door construction are shown on drawing (ADF-DCD01/2011)

INSULATION:

The hollow cores are filled with 39kg./cu.m. (2.2lbs./cu.ft.) Density of Polyurethane foam Insulation that provides thermal insulation qualities that reduces external noise and creates a more pleasant internal environment within the structures. As an alternate insulation, as required by client, can be filled with 100kg./cu.m high density Rockwool which has perfect flammability specifications for stopping the fire spreading and move, specially for the fire rated and external doors.



GENERAL DOORS

The quality and reliability of **ADF** general or ordinary doors and frames have made them a favoured choice for construction projects here in Saudi Arabia and the GCC. Using only the highest quality materials and manufacturing techniques, **ADF** produces metal doors and frames in a wide variety of sizes, gauges, and styles to meet the full range of safety, security and aesthetic requirements.



ADF can provide most types and styles of steel doors and frames for interior and exterior use and is one of the few manufacturers able to deliver both custom and standard doors and frames on the same order. Through our ability to produce uniquely designed doors and frames, **ADF** offers architects total design freedom.

STANDARD FEATURES:

- **Frame / Panel Thicknesses:** 1.2mm-3.0mm / 0.8mm-2.0mm
- **Door Thickness:** 38mm- 48mm.
- **Insulation:** Polyurethane/Rockwool
- **Material:** Galvanized Steel (GI) ASTM A526 G90
- **Finish:** Blast shot Primer, Powder coated Primer or powder coated top coat as per customer requirements.
- **Louvers & Vision Lights:** All sizes of louvers and vision lights are applicable as per required and specified.
- **Hardware:** ADF doors are designed to work with all kind of hardware and accessories specified for it.

FINAL USAGE OF ADF METAL DOORS:

Commercial Buildings	Shopping Malls	Industrial Plants
Multiplexes	Auditoriums	Metro Stations
Hotels	Airports	Software Parks
Recording Studios	Schools & colleges	Residential Buildings





GLASS LIGHTS:

The doors may be provided with viewing glass with a variety of sizes as shown on the drawings. After the door has been cut out to accept the glass light, the inner perimeter of the cut out shall be reinforced using C-channel type glass framing that consist of 1.5mm.thk. galvanized steel sheets tack welded to the door skin.

The outer perimeter of the glass framing that holds the glass, are consist of 1.2mm.thk galvanized steel sheets that are formed according to the designed details as shown on the drawing. It is tack welded on the outer side of the door skin and fixed with screw on the inner side of the door skin. The glass and seals requirements are usually provided by the contractor or owner.

LOUVERS:

Door louvers, when required, may be provided as an assembled unit. Louver blades are constructed on two different standard designs as shown on the drawing, mainly Z-type and inverted Y designs. It is constructed using 1.2mm thick galvanized steel sheets for louver blades & 1.5mm.thk galvanized steel sheets for louver framings. The inner perimeter of the louver cut out are reinforced with C-channel type @ 15mm. X 41mm. tack welded to the door skin. The outer perimeter frames are reinforced with C-channel type @ 15mm. X 46.4mm.

Louvers may be installed in single doors or in each leaf of a pair of doors and either is located at bottom portion or top portion of the door panel.

DOOR FRAMES:

The frame in which the door was mounted was a pressed steel type frame, consisting of a head and jamb pieces manufactured from 1.5mm thick galvanized steel sheets with 16mm. high stops. It is constructed either at single rabbet or double rabbet jamb designs, as shown on the drawing.

The frame depth varies according to client s requirement or either to the existing finish masonry wall thicknesses. The appropriate latch and hinge reinforcements along with the attachment of masonry strap type anchor bolt reinforcements were provided. Thicker frames up to 3.0mm sheets, as required, can be constructed on specially ordered frames. Frames with transoms are also provided, when required, and are based on given dimensions & designs by the contractor or client. Transom with fixed glass lights includes metal beads or clippings, glass are not included. Transoms can be provided with fixed or swinging type panels and removable transom bars.



HARDWARE REINFORCEMENTS:

Detect the type of hardware required by the customer for installation and the door's swing orientations prior to the manufacture of the doors, in order to design and fabricate the desired reinforcements for this kind of hardware since each kind of hardware has its uniqueness.



LOCKSET REINFORCEMENT - All doors are provided with reinforcements and cut-outs for locks or latches. The reinforcements are consisting of a U-shaped 1.5mm.thk galvanized steel sheets with the dimensions of 41mm.thk. X 100mm.width X 300mm.length. Latch reinforcements are consisting of two 3.0mm.thk. Steel tabs mounted around the latch cut-outs that are fully welded along their tails to the seaming edge.



PUSH / PULL REINFORCEMENT - All doors are provided with reinforcements for Push / Pull set. The reinforcements are consisting of a U-shaped 1.5mm.thk galvanized steel sheets with the dimensions of 41mm.thk. X 100mm.width X 600mm.length.



HINGE REINFORCEMENT - All doors are provided with reinforcements and cut-outs for hinges. The reinforcements are consisting of three 4mm.thk steel black iron sheets @ 37mm.width x 190mm. length fully welded along their tails to the seaming edge. Doors exceeding 2200mm. height are provided with an additional hinge and reinforcement for each additional 600mm. in height or fraction thereof.



CLOSER REINFORCEMENT - Door closer reinforcements are constructed and secured at the top panel opposite side of lockset reinforcement. The reinforcement is consisting of one U-shaped 1.5mm.thk galvanized steel sheets @ 41.6mm.thk. X 100mm. Width X300mm. Length.



PANIC DEVICE REINFORCEMENT - Panic device reinforcement are constructed and installed when the required locking system for the door are panic device mechanism. It is usually used for fire exit doors, exit stairs and emergency exit lobby. The reinforcement is consisting of two U-shaped 1.5mm.thick galvanized steel sheets @ 41mm.thk X 100mm. width X 300mm. length. It is installed at both sides of the door where lockset reinforcement is located.



BOTTOM HARDWARE REINFORCEMENT - All doors are provided with bottom hardware reinforcement for the purpose of installing door stoppers and other bottom hardware provisions at door panel, as required by the customer. It is constructed and installed at the bottom panel along the lockset reinforcement. The reinforcement is consisting of one U-shaped 1.5mm.thk galvanized steel sheets @ 41.6mm thick X 80mm. width X 180mm length.



STANDARD DOOR TYPES

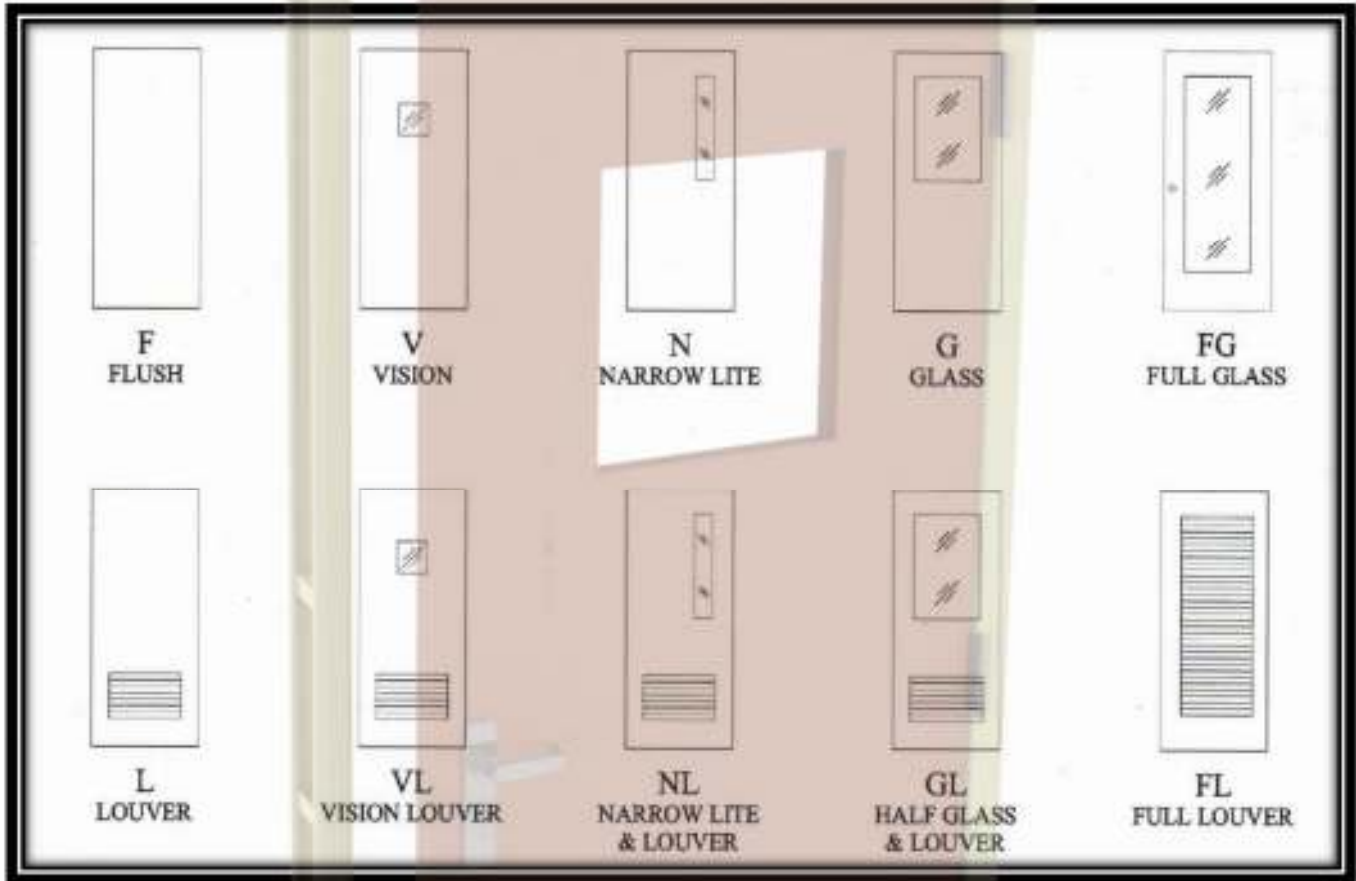

Our Products



STANDARD DOOR DIRECTIONS

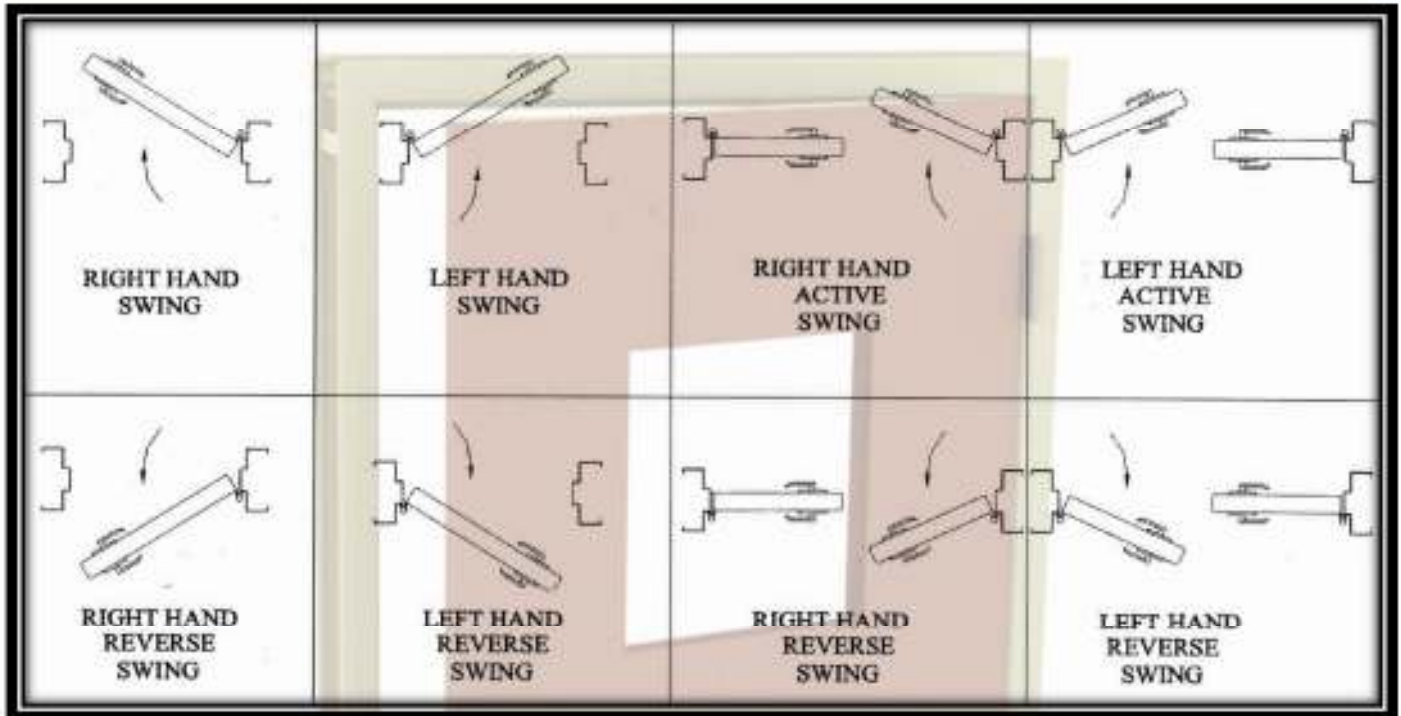

STANDARD DOOR CUT-OUTS & DIMENSIONS

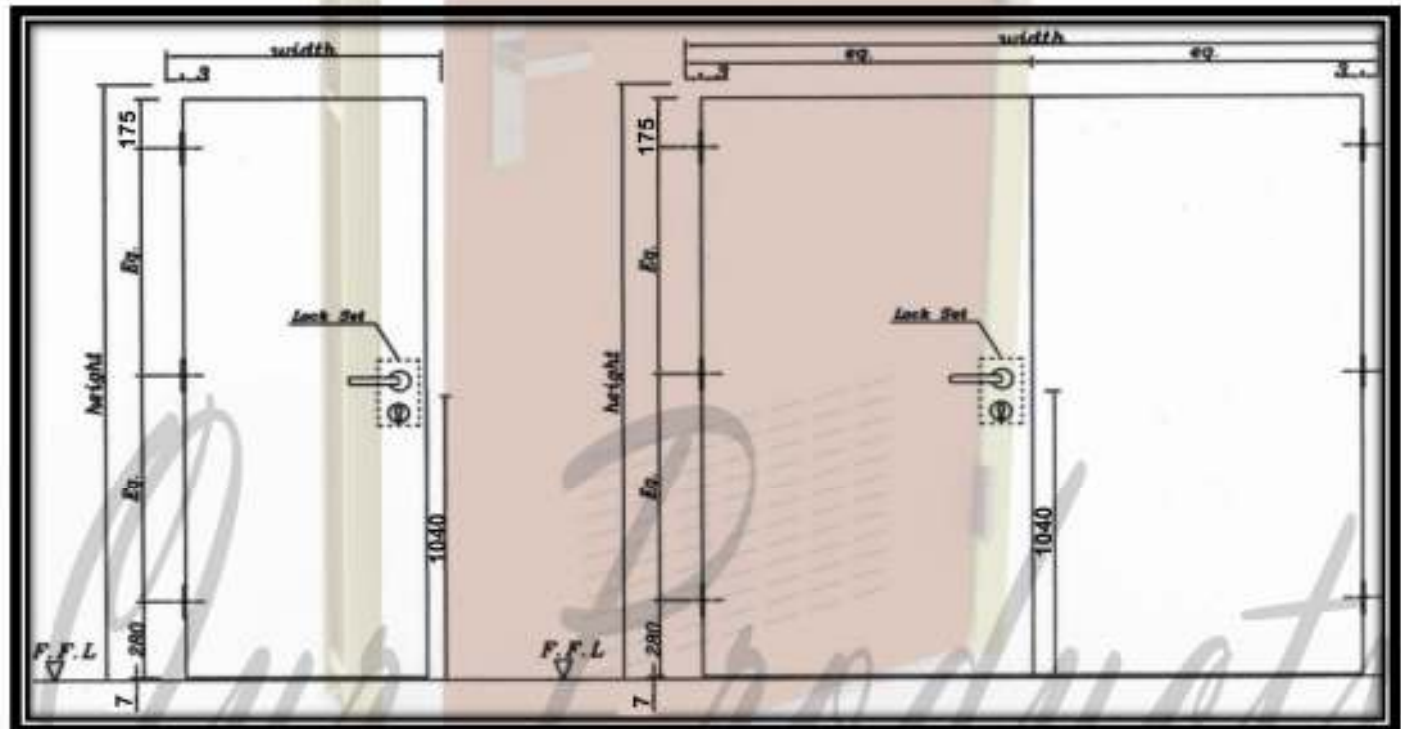

SINGLE DOORS

DOUBLE DOORS

STANDARD ANCHORING TYPES

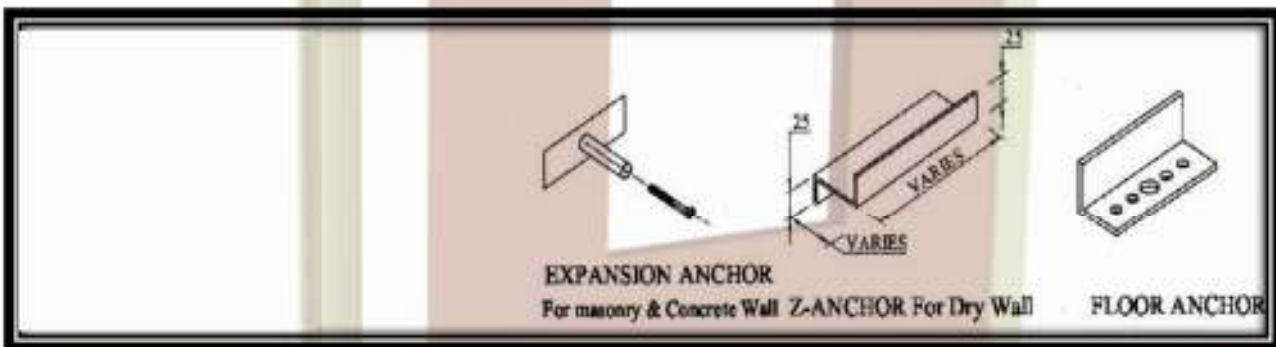
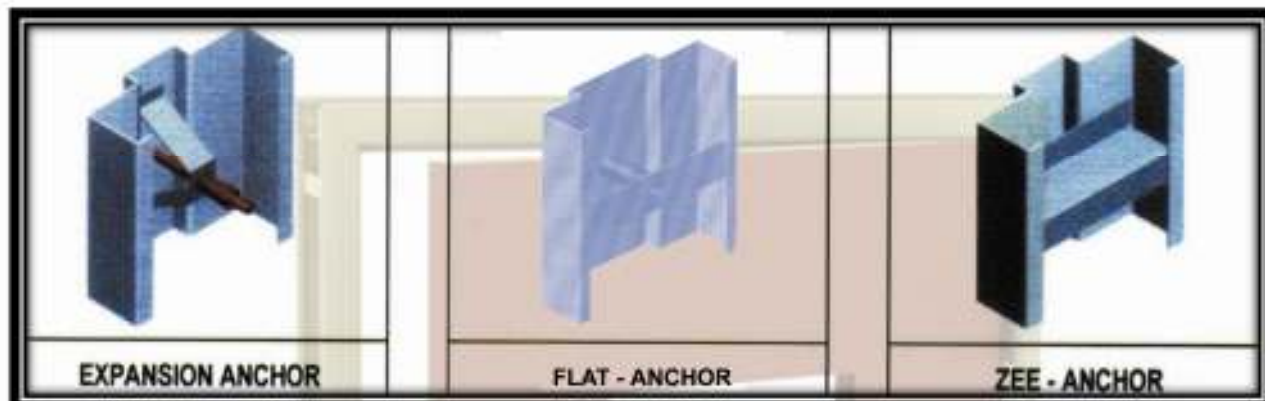

STANDARD FRAMES JOINTING TYPES

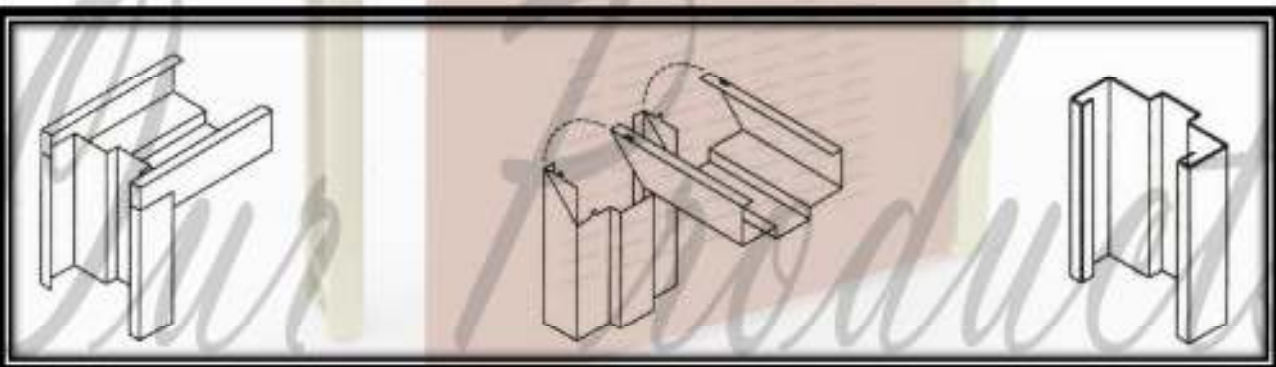
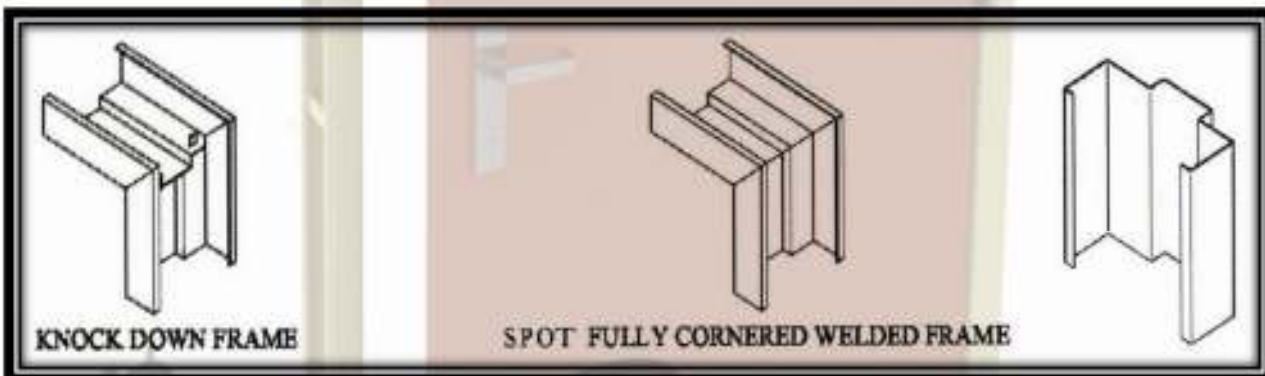

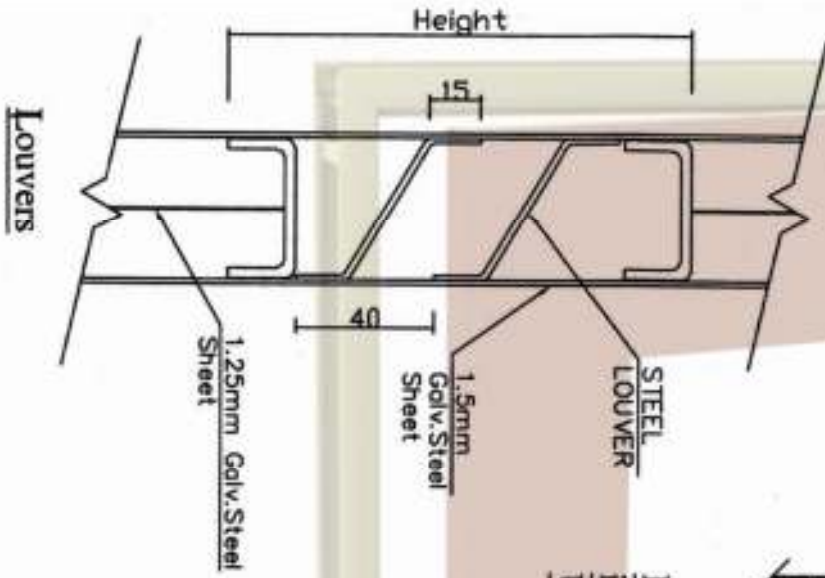

lock strike Preparation



Flush Top and inverted bottom U-channels

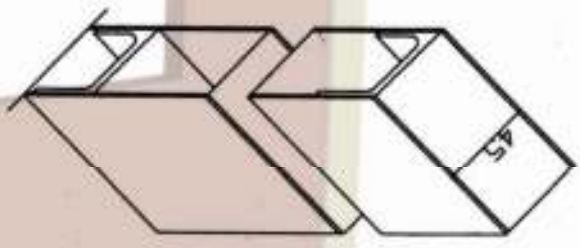

Vertical Steel Stiffener

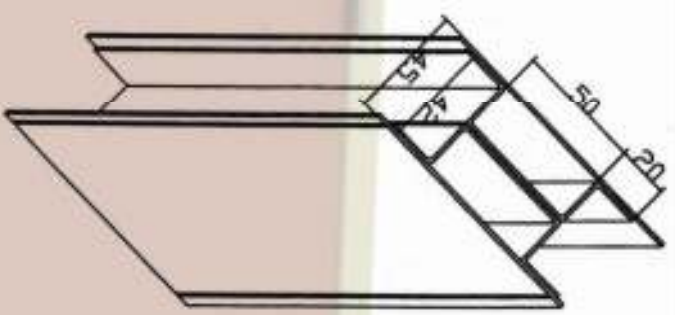

Hinge Preparation

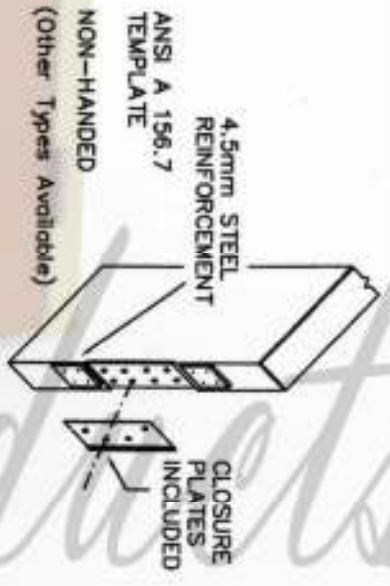

Glazing

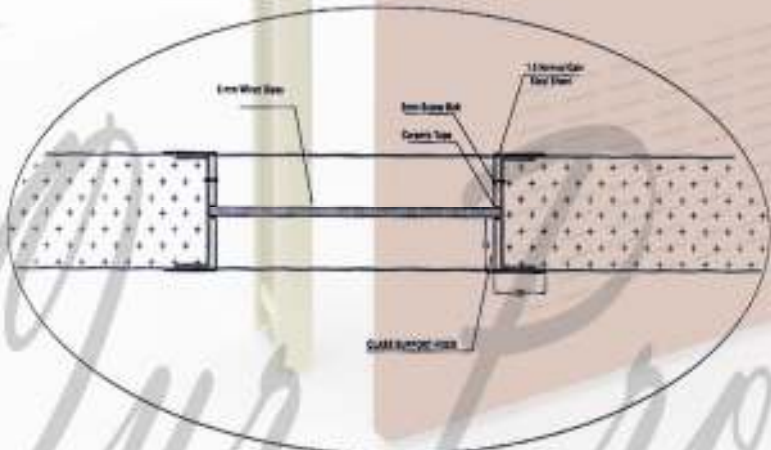



FIRE RESISTANT DOORS

ADF manufactures fire rated hollow metal doors and frames which carry the Underwriters Laboratory (UL) label. They are designed to meet the life-safety requirements in various types of buildings and structures that are compartmentalized to contain the spread of fire.

UL is an internationally recognized, independent laboratory, with a factory validation program that assures conformity of the product to the tested procedure. All labeled doors carry a **UL Metal** label on the doors and frames. **ADF** UL Labeled products offers the architects, designers and specifiers community various options in door and hardware to suit the design concept in areas of fire containment.

When you are choosing **ADF** fire rated door and frame for your projects, consider the many benefits of our doors. **ADF** Fire rated steel doors are rigid, durable, long lasting and offer great endurance through time. They resist environmental stresses like heat and humidity, and it can withstand all type of fires and prevent them from spreading and transfer. **ADF** fire rated steel doors are the best solutions in settings demanding a high degree of security; the applications in which they can use are almost limitless. Also it has a remarkable degree of design freedom they afford to architects and designers.

ADF fire rated doors have been tested in accordance with UL10B, and listed by Underwriters Laboratories (UL).

STANDARD FEATURES:

- **Frame / Panel Thicknesses:** 1.5mm-3.0mm / 1.2mm-2.0mm
- **Door Thickness:** 48mm.
- **Insulation:** Rockwool with 100 Kg/cu.Mt.
- **Material:** Galvanized Steel (GI) - ASTM A526 G90
- **Finish:** Powder coated Primer or powder coated top coat as per customer requirements.
- **Louvers & Vision Lights:** Please refer to the basic requirements for vision glasses and louvers.
- **Hardware:** ADF doors are designed to work with all kind of hardware and accessories but it should be a fire rated hardware with the same rating as per the door.



Underwriters
Laboratories



FULLY LOUVER DOORS & FIXED LOUVERS

ADF provides a wide variety of louver models and finishes within each category of louver types. **ADF** louvers serve a specific needs and requirements to control the environment and air movement.

Heavy-duty galvanized construction, (1.2 - 2.0) mm Thickness Material

ADF are built for durability yet offer a look that is both light and airy. Blending in with several architectural styles, **ADF** louvered doors are at home in decors ranging from half louvered to fully louvered doors. We build our louvered doors with your choice of Fixed or Operable louvers as well as false louvers where no ventilation is needed. **ADF** Steel louvers are designed and applied in custom lengths ready for quick installation. The Special design allows free flow of air, restricting entry of water and dust, Light weight, ready to install, Long Life and Maintenance free.

STANDARD FEATURES:

- **Frame / Blades:** 2.0mm / 1.2mm
- **Door Thickness:** 84 mm.
- **Material:** Galvanized Steel (GI) - ASTM A526 G90
- **Finish:** Powder coated Primer or powder coated top coat as per customer requirements.
- **Hardware:** ADF doors are designed to work with all kind of hardware and accessories.





KNOCK DOWN FRAMES

Hollow metal frames could be fabricated in two types based on the jointing style: welded and knock-down. Welded frames come in a single piece with all corners welded and ground smoothly. This type of frames is positioned first and partitions (gypsum board on metal studs or masonry) are built to it or after there will be a grouting all around the frame. Knock Down frames made of three pieces, two jambs and then the header and they are installed after the partitions are in place; this type of frame is usually used with drywall and gypsum board construction and it is not durable as the welded frames. But it can be used where the fire rating is specified, and mostly it's easier in fixation.

ADF has a full range of knock down frames of standard sizes and profiles. Knock down frames are available in 16 gauges for 1 3/4" doors or as per specified by the customers. All standard knock down frames are manufactured from galvanized steel and are prepared and reinforced to receive specific architectural hardware in accordance to ANSI A115 Standards.

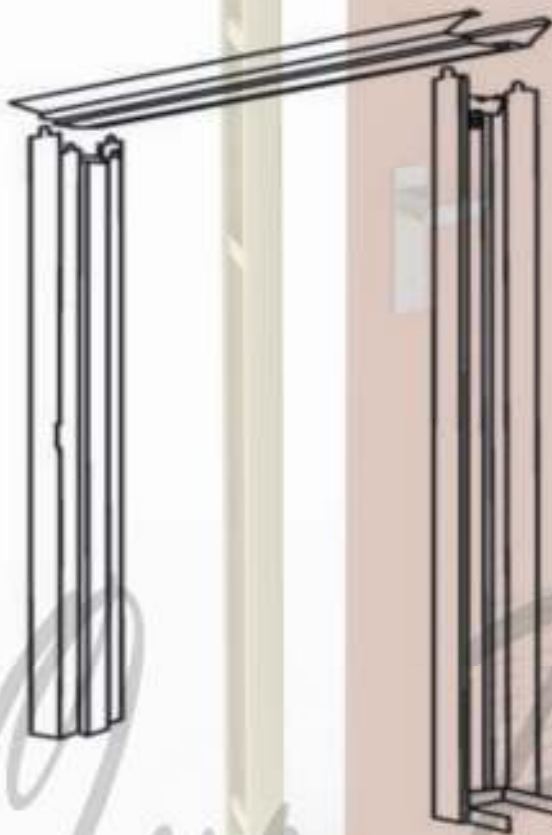

Our **ADF** Standard knock down frame widths range from 700mm to 1100mm with height from 1800mm to 2400mm. Frame depth sizes range from 130mm to 300mm.

Standard knock down for double doors widths range from 900mm to 2500mm with height from 1800mm to 2400mm. Frame depth sizes range from 130mm to 300mm.

Hinge sides are prepared and reinforced to receive 3 to 4 standard weight 4 1/2 x 4 1/2 butt or as per the requirements of the client with regards to the hanging system.

Strike sides are prepared and reinforced to receive any kind of strikes with accordance to ANSI A115.1.

Hinge and strike jambs are supplied with appropriate wall anchors.



ACCESS PANELS

ADF would like to introduce our new expanded range of products which is Access Panels. You may already be familiar with our very popular Hollow Metal Doors but **ADF** now offer a fantastic range of metal access panels.

ADF access panel has a wide range of high quality sizes, shapes and finish hardware. It's also available with a fire rated specifications and non-fire rated specifications for multi usage and installation purposes. **ADF** metal access panels are designed to provide simple, easy access through dry lined walls, ceilings, ducts and units to gain access to concealed plumbing, switches, valves, stopcocks, fuse boxes, controls and connections when plastic is not the preferred choice

ADF fire rated access panels are produced in a different sizes up to the maximum sizes allowed by our fire resistance certificate circumstances.

STANDARD FEATURES:

- **Frame / Panels:** 1.5mm-2.0mm / 1.2mm- 1.5 mm

Other specified thicknesses are also applicable

- **Door Thickness:** 45mm 48 mm
- **Material:** Galvanized Steel (GI) - ASTM A526 G90
- **Finish:** Powder coated Primer or powder coated top coat as per customer requirements.
- **Hardware:** ADF doors are designed to work with all kind of hardware and accessories since its rigid and high quality.





X-RAY DOORS (LEAD LINE DOORS)

ADF make a lead line doors for medical and industrial shielding applications. They are available in all the required sizes and Swing, mechanisms as per the requirements of the customer. **ADF** offers single and double rabbet door frames in welded or knock down configurations with prep for all types of hardware configurations to meet the architect specifications.

ADF offers a premium line of Lead-Lined Metal Doors are manufactured to have an equal appearance to architectural designed doors and frames. Designed and constructed with the highest quality materials available and craftsmanship you would expect. Doors are designed to take into consideration the heavy weight that sheet lead imposes on them. They are constructed to support this extra weight, which will not detract from their appearance or radiation protection. The frames are designed to support the lead lined doors to provide a lead lined interface between the door and the lead lined wall in the adjacent walls. Usually they are attached to studs in the walls using a variety of techniques specifically designed to hold the door securely and prevent radiation shielding leakage.



The Lead thickness is determined by the intended application of the product

and the determination of thickness is the responsibility of the purchaser. For Hollow Metal Frames and Doors the lead sheet is applied to the inside of the skin of the door on the "pull" side. The Lead Sheet is applied to the face, rabbet, stop, and part of the soffit on the door rebate side of the frame.



Our Products

**STANDARD FEATURES:**

- **Frame / Panel Thicknesses:** 1.5mm-3.0mm / 1.2mm-2.0mm
- **Door Thickness:** 45mm – 48mm.
- **Insulation:** Polyurethane, or Rockwool. With a (2 mm) thick. Pure Lead Sheet from the inside of the door.
- **Material:** Galvanized Steel (GI) - ASTM A526 G90
- **Finish:** Powder coated Primer or powder coated top coat as per customer requirements.
- **Hardware:** ADF doors are designed to work with all kind of hardware and accessories but it should be a fire rated hardware with the same rating as per the door.



Our Products



Fixed WINDOWS & FRONT SHOPS

We are a known name in manufacturing of metal windows that are ergonomically designed to lend style to the interiors as well as exteriors. Made from the highest grades of galvanized sheet, these fixed metal windows come in variety of sizes and are either Single Glazed or Double Glazed depending on the customer requirement. These windows are available in different dimensions and colours to suit the customer's choice.



As a premier supplier of shop fronts, we have supplied and installed shop fronts for many leading retailers. We always strive for the highest standard of product, workmanship, and finish. Our frames can be manufactured from a variety of materials and finishes including:

- Powder coated steel

The Frames comprise a mechanical or welded joint construction.

STANDARD FEATURES:

- **Frame:** 1.5mm-3.0mm .
- **Material:** Galvanized Steel (GI) - ASTM A526 G90
- **Finish:** Powder coated Primer or powder coated top coat as per customer requirements.

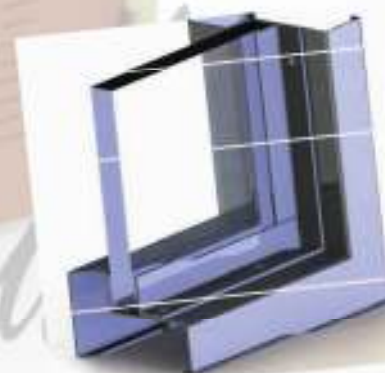



ADF[®]

Hardware



CONTACT US (OUR LOCATION)

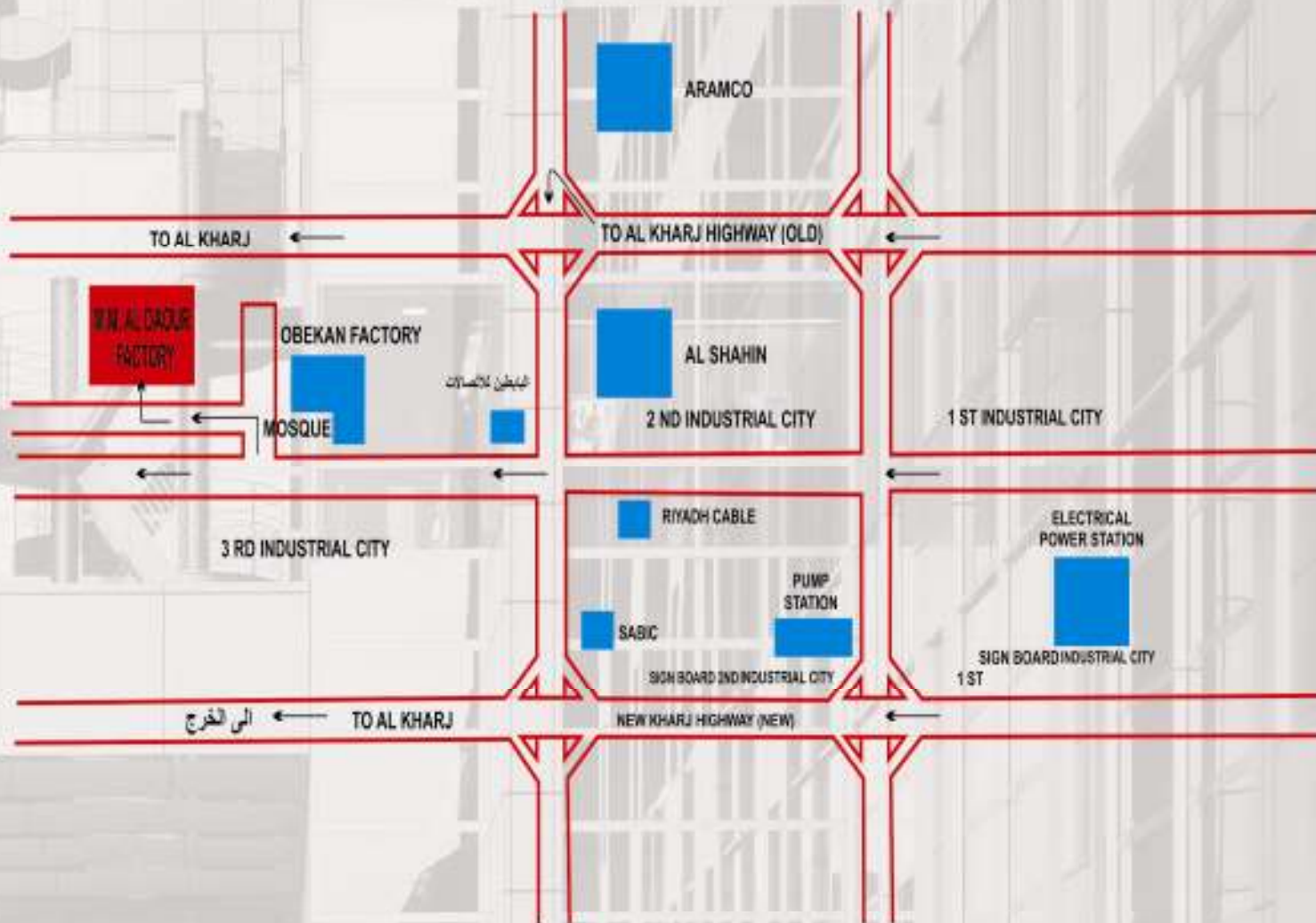

AL DAOUR FOR METAL INDUSTRIES
KINGDOM OF SAUDI ARABIA - RIYADH, P.O.-BOX355671
RIYADH FACTORY: TEL.: 1 2654551 FAX: +966 1 2654550
SALES OFFICE TEL:+966 1 2006215 FAX: +966 1 2006219
E-mail: info@adf.com.sa website: www.adf.com.sa

Contacts



AL DAOUR FOR METAL INDUSTRIES

Company Profile



BUREAU VERITAS
Certification



ISO 9001 : 2008